

DSR

GradUp

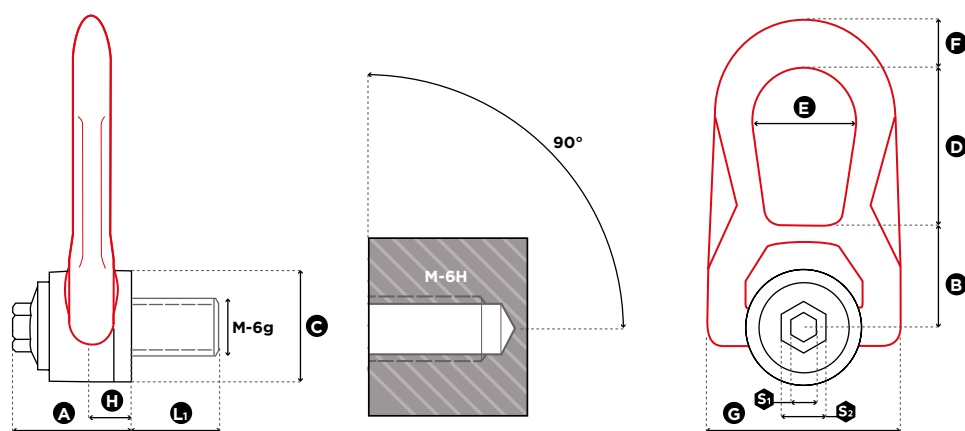

DOUBLE SWIVEL RING



1 in = 25.4 mm

Reference	Diameter	SF 5:1 WLL (t)	SF 4:1 WLL (t)	Standard L ₁ (mm)	Torque (Nm)	S ₁ (mm)	S ₂ (mm)	A (mm)	B (mm)	C (mm)	D (mm)	E (mm)	F (mm)	G (mm)	H (mm)	Weight (kg)
DSR M 5 UP	M 5 (x0,8)	0,07	0,10	15	3	8	16	33	30	30	38	27	14	53	9,5	0,3
DSR M 6 UP	M 6 (x1)	0,15	0,20	15	4	8	16	33	30	30	38	27	14	53	9,5	0,3
DSR M 8 UP	M 8 (x1,25)	0,40	0,50	15	6	8	16	33	30	30	38	27	14	53	9,5	0,3
DSR M 10 UP	M 10 (x1,5)	0,70	0,90	18	10	8	16	33	30	30	38	27	14	53	9,5	0,3
DSR M 12 UP	M 12 (x1,75)	1,05	1,30	21	15	8	16	33	30	30	38	27	14	53	9,5	0,3
DSR M 14 UP	M 14 (x2)	1,40	1,80	23	30	8	20	45	40	45	53	38	17	76	13	0,9
DSR M 16 UP	M 16 (x2)	2,00	2,30	27	50	8	20	45	40	45	53	38	17	76	13	0,9
DSR M 18 UP	M 18 (x2,5)	2,30	2,30	27	70	8	20	45	40	45	53	38	17	76	13	0,9
DSR M 20 2t5 UP	M 20 (x2,5)	2,50	2,50	30	100	8	20	45	40	45	53	38	17	76	13	0,9
DSR M 20 3t2 UP	M 20 (x2,5)	2,90	3,20	25	100	14	24	62	55	60	83	55	25	115	19	2,6
DSR M 22 UP	M 22 (x2,5)	3,50	4,50	33	120	14	24	62	55	60	83	55	25	115	19	2,6
DSR M 24 UP	M 24 (x3)	4,40	5,50	36	160	14	24	62	55	60	83	55	25	115	19	2,6
DSR M 27 UP	M 27 (x3)	5,70	6,00	40	200	14	24	62	55	60	83	55	25	115	19	2,7
DSR M 30 6t3 UP	M 30 (x3,5)	6,00	6,30	45	250	14	24	62	55	60	83	55	25	115	19	2,7
DSR M 30 8t UP	M 30 (x3,5)	6,70	8,00	45	250	14	30	80	77	78	98	71	26	141	28	5,4
DSR M 36 UP	M 36 (x4)	8,00	8,50	54	320	14	30	80	77	78	98	71	26	141	28	5,4
DSR M 42 UP	M 42 (x4,5)	8,50	9,00	63	400	14	30	80	77	78	98	71	26	141	28	5,5