

DSS

GradUp



METRIC THREADS

DOUBLE SWIVEL SHACKLE

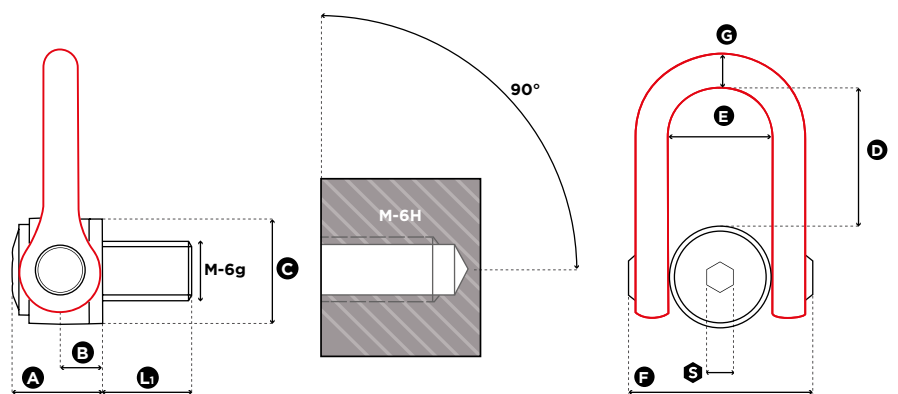

1 in = 25.4 mm

Reference	Diameter	SF 5:1 WLL (t)	SF 4:1 WLL (t)	Standard L ₁ (mm)	Torque (Nm)	S (mm)	A (mm)	B (mm)	C (mm)	D (mm)	E (mm)	F (mm)	G (mm)	Weight (kg)
DSS M 24 UP	M 24 (x3)	4,50	5,50	36	160	19	61	31	70	98	73	149	33	5,4
DSS M 30 UP	M 30 (x3,5)	7,70	8,50	45	250	19	61	31	70	98	73	149	33	5,5
DSS M 33 UP	M 33 (x3,5)	8,50	10,50	50	250	19	61	31	70	98	73	149	33	5,5
DSS M 36 UP	M 36 (x4)	11,00	12,00	54	320	19	61	31	70	98	73	149	33	5,5
DSS M 36x3 UP	M 36 (x3)	11,00	12,00	54	320	19	61	31	70	98	73	149	33	5,5
DSS M 39 UP	M 39 (x4)	12,00	14,00	58	320	19	61	31	70	98	73	149	33	5,7
DSS M 42 UP	M 42 (x4,5)	13,00	15,00	63	400	19	61	31	70	98	73	149	33	5,8
DSS M 42x3 UP	M 42 (x3)	13,00	15,00	63	400	19	61	31	70	98	73	149	33	5,8
DSS M 45 UP	M 45 (x4,5)	14,50	16,00	63	400	19	61	31	70	98	73	149	33	5,9
DSS M 48 UP	M 48 (x5)	17,00	20,00	68	600	19	79	38	90	123	91	182	45	11,0
DSS M 48x3 UP	M 48 (x3)	17,00	20,00	68	600	19	79	38	90	123	91	182	45	11,0
DSS M 48x4 UP	M 48 (x4)	17,00	20,00	68	600	19	79	38	90	123	91	182	45	11,0
DSS M 52 UP	M 52 (x5)	19,00	21,00	68	600	19	79	38	90	123	91	182	45	11,2
DSS M 56 UP	M 56 (x5,5)	22,00	25,00	78	600	19	79	38	90	123	91	182	45	11,3
DSS M 56x4 UP	M 56 (x4)	22,00	25,00	78	600	19	79	38	90	123	91	182	45	11,4
DSS M 64 UP	M 64 (x6)	25,00	32,10	90	600	19	79	38	95	123	91	182	45	12,2
DSS M 64x4 UP	M 64 (x4)	25,00	32,10	90	600	19	79	38	95	123	91	182	45	12,2
DSS M 72 UP	M 72 (x6)	22,00	25,00	90	600	19	79	38	95	123	91	182	45	14,0
DSS M 72x4 UP	M 72 (x4)	22,00	25,00	90	600	19	79	38	95	123	91	182	45	14,0
DSS M 80 UP	M 80 (x6)	25,00	32,10	90	600	19	79	38	100	123	91	182	45	15,0
DSS M 90 UP	M 90 (x6)	25,00	32,10	90	600	19	79	38	100	123	91	182	45	15,5
DSS M 100 UP	M 100 (x6)	25,00	32,10	90	600	19	79	38	110	123	91	182	45	16,5

10.2021