

FE.DSS

FEMALE DOUBLE SWIVEL SHACKLE

GradUp

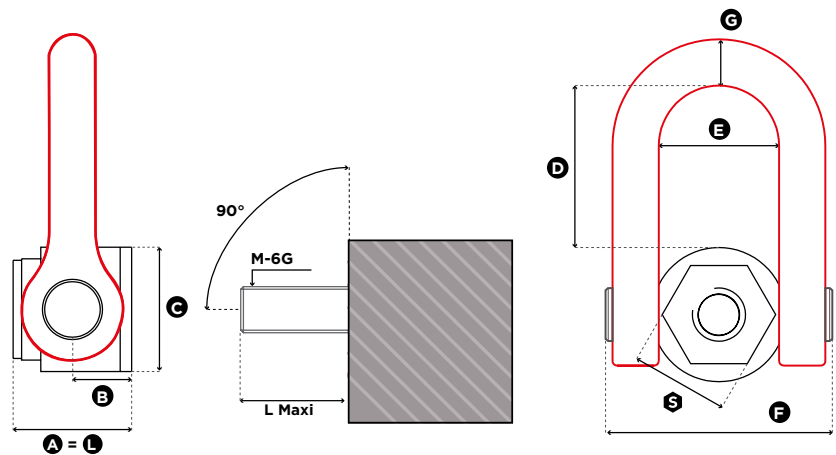

1 in = 25.4 mm

Reference	Diameter	SF 5:1 WLL (t)	SF 4:1 WLL (t)	L Maxi (mm)	Torque (Nm)	S (mm)	A (mm)	B (mm)	C (mm)	D (mm)	E (mm)	F (mm)	G (mm)	Weight (kg)
FE.DSS M 24 UP	M 24 (x3)	4,50	5,50	66	160	50	66	31	70	98	73	149	33	5,1
FE.DSS M 27 UP	M 27 (x3)	5,20	6,50	66	200	50	66	31	70	98	73	149	33	5,1
FE.DSS M 30 UP	M 30 (x3,5)	7,50	8,50	66	250	50	66	31	70	98	73	149	33	5,1
FE.DSS M 33 UP	M 33 (x3,5)	8,00	10,50	66	250	50	66	31	70	98	73	149	33	5,1
FE.DSS M 36 UP	M 36 (x4)	10,00	12,00	66	320	50	66	31	70	98	73	149	33	5,1
FE.DSS M 39 UP	M 39 (x4)	12,00	14,00	89	320	60	89	38	95	123	91	182	45	10,0
FE.DSS M 42 UP	M 42 (x4,5)	13,00	15,00	89	400	60	89	38	95	123	91	182	45	10,0
FE.DSS M 45 UP	M 45 (x4,5)	14,50	16,00	89	400	60	89	38	95	123	91	182	45	10,0
FE.DSS M 48 UP	M 48 (x5)	17,00	20,00	89	600	60	89	38	95	123	91	182	45	10,0
FE.DSS M 52 UP	M 52 (x5)	19,00	21,00	89	600	60	89	38	95	123	91	182	45	10,0